

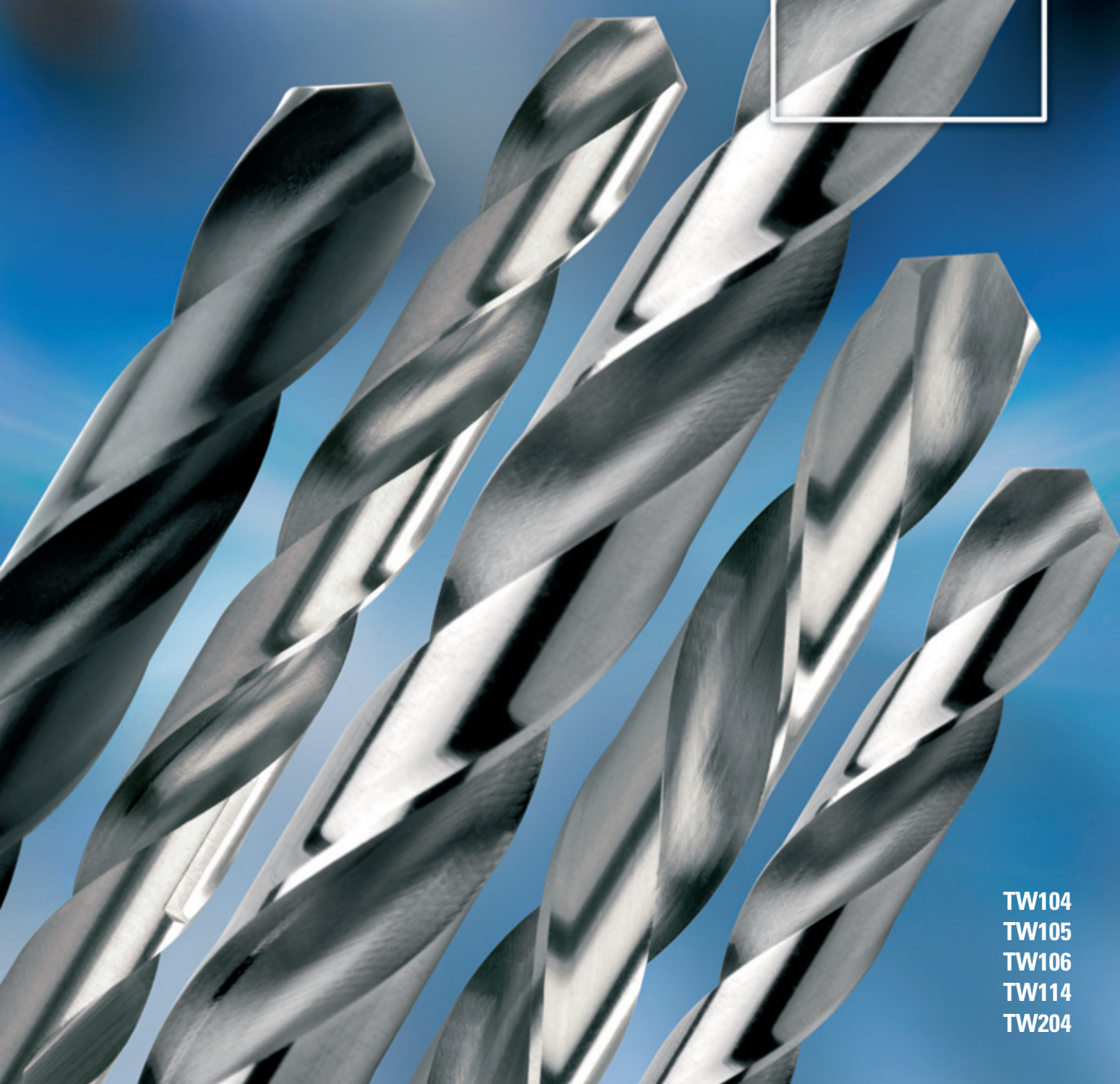

BROCAS PARA  
APLICAÇÃO GERAL

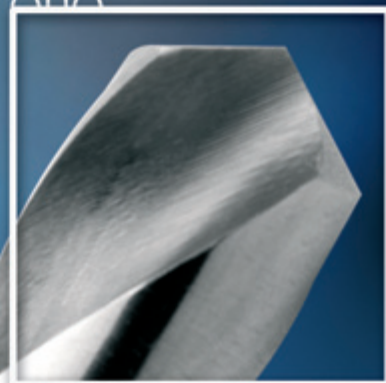

TW104  
TW105  
TW106  
TW114  
TW204

MAIS QUE PRODUTOS. PRODUTIVIDADE.

**BROCAS PARA APLICAÇÃO GERAL LENOX-TWILL**  
DESENVOLVIDAS PARA FURAR UMA AMPLA GAMA DE MATERIAIS, PROPORCIONANDO DESEMPENHO EFICIENTE COM EXCELENTE RELAÇÃO CUSTO-BENEFÍCIO. IDEAL PARA QUEM NECESSITA VERSATILIDADE DE APLICAÇÃO A UM BAIXO CUSTO.

Conheça suas características:

## ATO RÁPIDO HSS

Fabricadas em aço rápido (HSS) com tratamento térmico especial, o qual proporciona alta dureza e tenacidade à ferramenta.



## ACABAMENTO SUPERFICIAL POLIDO

É o acabamento mais usual para brocas de aço rápido. Possui baixo coeficiente de atrito, o que diminui a adesão a frio do cavaco nas arestas de corte. Disponível nas normas DIN 338 e DIN 340.



## ACABAMENTO SUPERFICIAL TTX

As brocas TTX possuem uma camada externa de nitretação que aumenta a durabilidade da aresta de corte em até 30%.

São especialmente recomendadas para furação de aços e materiais abrasivos como ferro fundido. Disponíveis na norma DIN 338.



## CANAIS

Geometria tipo N. Retificados com máxima precisão e simetria, garantindo excelente estabilidade operacional e eficiente remoção de cavacos.

## PONTA

Afição a 118° permite trabalhar com facilidade uma ampla gama de materiais. Ideal para quem necessita utilizar uma mesma broca para furar diferentes tipos de material.

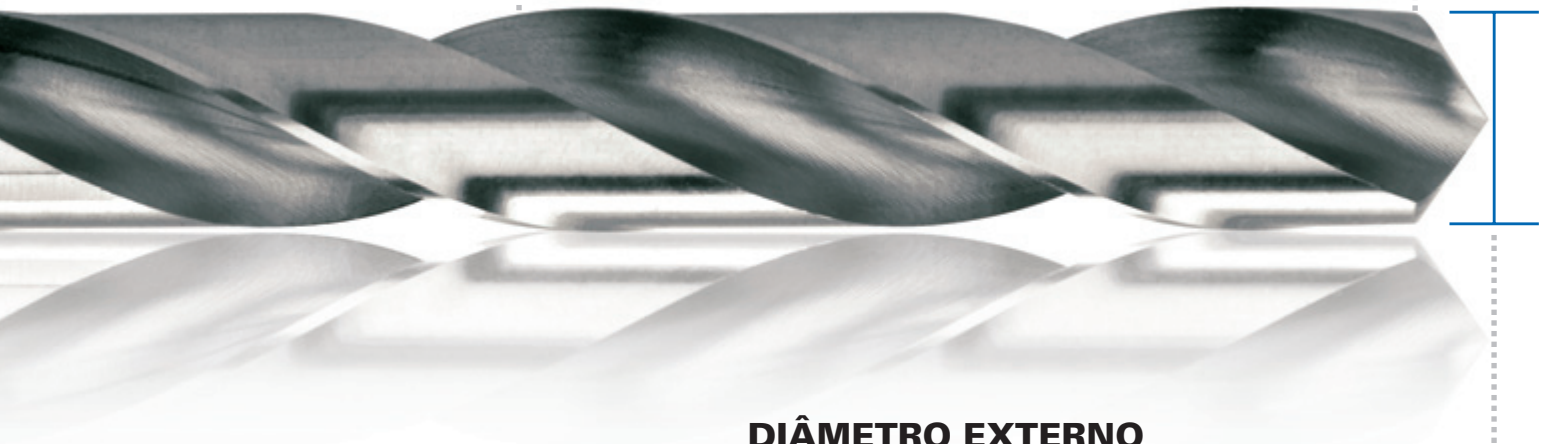
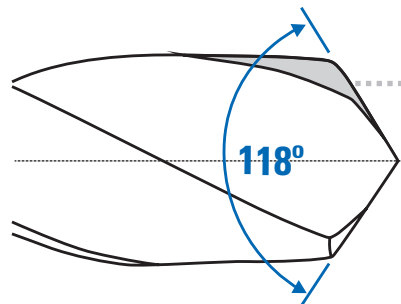

## DIÂMETRO EXTERNO

Obtido por processo de retifica centerless com tolerância h8 e batimento máximo de xyz.

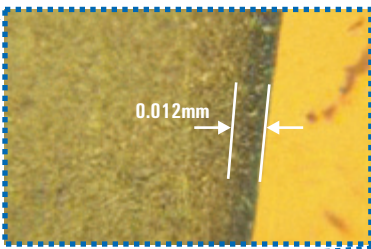

## BROCAS PARA APLICAÇÃO GERAL



## BROCAS PARA APLICAÇÃO GERAL

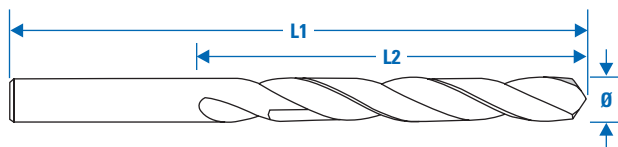

Diâmetro (mm)		Tolerância h8 (mm)
> 0,600 a	0,950	+0,000 / -0,012
> 0,950 a	3,000	+0,000 / -0,014
> 3,000 a	6,000	+0,000 / -0,018
> 6,000 a	10,000	+0,000 / -0,022
> 10,000 a	18,000	+0,000 / -0,027

### TW104

**Norma:** DIN 338  
**Material:** HSS  
**Ponta:** 118°  
**Acabamento:** Brilhante



Código	Ø (mm)	L2 (mm)	L1 (mm)	Código	Ø (mm)	L2 (mm)	L1 (mm)	Código	Ø (mm)	L2 (mm)	L1 (mm)	Código	Ø (mm)	L2 (mm)	L1 (mm)
40000	0,50	6	22	40038	2,50	30	57	40076	5,30	52	86	40114	8,50	75	117
40001	0,60	7	24	40039	2,55	30	57	40077	5,40	57	93	40115	8,60	81	125
40002	0,70	9	28	40040	2,60	30	57	40078	5,50	57	93	40116	8,70	81	125
40003	0,75	9	28	40041	2,65	30	57	40079	5,60	57	93	40117	8,75	81	125
40004	0,80	10	30	40042	2,70	33	61	40080	5,70	57	93	40118	8,80	81	125
40005	0,85	10	30	40043	2,75	33	61	40081	5,75	57	93	40119	8,90	81	125
40006	0,90	11	32	40044	2,80	33	61	40082	5,80	57	93	40120	9,00	81	125
40007	0,95	11	32	40045	2,85	33	61	40083	5,90	57	93	40121	9,10	81	125
40008	1,00	12	34	40046	2,90	33	61	40084	6,00	57	93	40122	9,20	81	125
40009	1,05	12	34	40047	2,95	33	61	40085	6,10	63	101	40123	9,25	81	125
40010	1,10	14	36	40048	3,00	33	61	40086	6,20	63	101	40124	9,30	81	125
40011	1,15	14	36	40049	3,10	36	65	40087	6,25	63	101	40125	9,40	81	125
40012	1,20	16	38	40050	3,20	36	65	40088	6,30	63	101	40126	9,50	81	125
40013	1,25	16	38	40051	3,25	36	65	40089	6,40	63	101	40127	9,60	87	133
40014	1,30	16	38	40052	3,30	36	65	40090	6,50	63	101	40128	9,70	87	133
40015	1,35	18	40	40053	3,40	39	70	40091	6,60	63	101	40129	9,75	87	133
40016	1,40	18	40	40054	3,50	39	70	40092	6,70	63	101	40130	9,80	87	133
40017	1,45	18	40	40055	3,60	39	70	40093	6,75	69	109	40131	9,90	87	133
40018	1,50	18	40	40056	3,70	39	70	40094	6,80	69	109	40132	10,00	87	133
40019	1,55	20	43	40057	3,75	39	70	40095	6,90	69	109	40133	10,10	87	133
40020	1,60	20	43	40058	3,80	43	75	40096	7,00	69	109	40134	10,20	87	133
40021	1,65	20	43	40059	3,90	43	75	40097	7,10	69	109	40135	10,25	87	133
40022	1,70	20	43	40060	4,00	43	75	40098	7,20	69	109	40136	10,30	87	133
40023	1,75	22	46	40061	4,10	43	75	40099	7,25	69	109	40137	10,40	87	133
40024	1,80	22	46	40062	4,20	43	75	40100	7,30	69	109	40138	10,50	87	133
40025	1,85	22	46	40063	4,25	43	75	40101	7,40	69	109	40139	10,60	87	133
40026	1,90	22	46	40064	4,30	47	80	40102	7,50	69	109	40140	10,70	94	142
40027	1,95	24	49	40065	4,40	47	80	40103	7,60	75	117	40141	10,75	94	142
40028	2,00	24	49	40066	4,50	47	80	40104	7,70	75	117	40142	10,80	94	142
40029	2,05	24	49	40067	4,60	47	80	40105	7,75	75	117	40143	10,90	94	142
40030	2,10	24	49	40068	4,70	47	80	40106	7,80	75	117	40144	11,00	94	142
40031	2,15	27	53	40069	4,75	47	80	40107	7,90	75	117	40145	11,10	94	142
40032	2,20	27	53	40070	4,80	52	86	40108	8,00	75	117	40146	11,20	94	142
40033	2,25	27	53	40071	4,90	52	86	40109	8,10	75	117	40147	11,25	94	142
40034	2,30	27	53	40072	5,00	52	86	40110	8,20	75	117	40148	11,30	94	142
40035	2,35	27	53	40073	5,10	52	86	40111	8,25	75	117	40149	11,40	94	142
40036	2,40	30	57	40074	5,20	52	86	40112	8,30	75	117	40150	11,50	94	142
40037	2,45	30	57	40075	5,25	52	86	40113	8,40	75	117	40151	11,60	94	142

**TW104** - continuação

Código	Ø (mm)	L2 (mm)	L1 (mm)
40190	16,50	125	184
40191	16,75	125	184
40192	17,00	125	184
40193	17,25	130	191
40194	17,50	130	191
40195	17,75	130	191
40196	18,00	130	191

Código	Ø (mm)	L2 (mm)	L1 (mm)
40197	18,25	135	198
40198	18,50	135	198
40199	18,75	135	198
40200	19,00	135	198
40201	19,25	140	205
40202	19,50	140	205
40203	19,75	140	205

Código	Ø (mm)	L2 (mm)	L1 (mm)
40204	20,00	140	205
40205	20,50	140	210
40206	21,00	140	210
40207	21,50	140	215
40208	22,00	140	215
40209	22,50	145	220
40210	23,00	145	220

Código	Ø (mm)	L2 (mm)	L1 (mm)
40211	23,50	145	220
40212	24,00	150	225
40213	24,50	150	225
40214	25,00	150	225
40215	25,50	155	230
40216	26,00	155	230
40217	27,00	160	235

Código	Ø (mm)	L2 (mm)	L1 (mm)
40218	28,00	160	235
40219	29,00	165	240
40220	30,00	165	240
40221	32,00	175	250

**TW105**

**Norma:** ANSI B 94.11 M  
**Material:** HSS  
**Ponta:** 118°  
**Acabamento:** Brilhante



Código	Ø (pol)	L2 (mm)	L1 (mm)
40222	1/32"	13	35
40223	3/64"	20	45
40224	1/16"	23	48
40225	5/64"	26	52
40226	3/32"	33	58
40227	7/64"	39	69
40228	1/8"	42	71
40229	9/64"	45	74
40230	5/32"	52	80
40231	11/64"	55	84
40232	3/16"	60	90

Código	Ø (pol)	L2 (mm)	L1 (mm)
40233	13/64"	64	94
40234	7/32"	66	97
40235	15/64"	69	100
40236	1/4"	72	104
40237	17/64"	75	107
40238	9/32"	77	110
40239	19/64"	80	113
40240	5/16"	83	116
40241	21/64"	86	119
40242	11/32"	90	124
40243	23/64"	92	127

Código	Ø (pol)	L2 (mm)	L1 (mm)
40244	3/8"	95	130
40245	25/64"	98	133
40246	13/32"	101	136
40247	27/64"	103	140
40248	7/16"	106	143
40249	29/64"	109	146
40250	15/32"	113	149
40251	31/64"	114	152
40252	1/2"	118	156
40253	33/64"	127	173
40254	17/32"	127	173

Código	Ø (pol)	L2 (mm)	L1 (mm)
40255	35/64"	127	173
40256	9/16"	127	173
40257	37/64"	127	173
40258	19/32"	137	186
40259	39/64"	137	186
40260	5/8"	137	186
40261	41/64"	137	186
40262	21/32"	137	186
40263	43/64"	148	200
40264	11/16"	148	200
40265	23/32"	135	198

Código	Ø (pol)	L2 (mm)	L1 (mm)
40266	47/64"	135	198
40267	3/4"	140	205
40268	49/64"	140	205
40269	25/32"	140	205
40270	13/16"	140	210
40271	27/32"	140	215
40272	7/8"	140	215
40273	15/16"	150	225
40274	1"	155	230

**TW106**

**Norma:** DIN 338  
**Material:** HSS  
**Ponta:** 118°  
**Acabamento:** Brilhante



Código	Ø (mm)	L2 (mm)	L1 (mm)
40396	1,00	12	34
40397	1,05	12	34
40398	1,10	14	36
40399	1,20	16	38
40400	1,30	16	38
40401	1,40	18	40
40402	1,50	18	40
40403	1,60	20	43
40404	1,70	20	43
40405	1,80	22	46
40406	1,90	22	46

Código	Ø (mm)	L2 (mm)	L1 (mm)
40407	2,00	24	49
40408	2,10	24	49
40409	2,20	27	53
40410	2,30	27	53
40411	2,40	30	57
40412	2,50	30	57
40413	2,60	30	57
40414	2,70	33	61
40415	2,80	33	61
40416	2,90	33	61
40417	3,00	33	61

Código	Ø (mm)	L2 (mm)	L1 (mm)
40418	3,10	36	65
40419	3,20	36	65
40420	3,30	36	65
40421	3,40	39	70
40422	3,50	39	70
40423	3,60	39	70
40424	3,70	39	70
40425	3,75	39	70
40426	3,80	43	75
40427	3,90	43	75
40428	4,00	43	75

Código	Ø (mm)	L2 (mm)	L1 (mm)
40429	4,20	43	75
40430	4,50	47	80
40431	4,80	52	86
40432	5,00	52	86
40433	5,50	57	93
40434	6,00	57	93
40435	6,50	63	101
40436	7,00	69	109
40437	7,50	69	109
40438	8,00	75	117
40439	8,50	75	117

Código	Ø (mm)	L2 (mm)	L1 (mm)
40440	9,00	81	125
40441	9,50	81	125
40442	10,00	87	133
40443	10,50	87	133
40444	11,00	94	142
40445	11,50	94	142
40446	12,00	101	151
40447	13,00	101	151

### TW114

**Norma:** DIN 338  
**Material:** HSS  
**Ponta:** 118°  
**Acabamento:** Nitretado TTX



Código	Ø (mm)	L2 (mm)	L1 (mm)	Código	Ø (mm)	L2 (mm)	L1 (mm)	Código	Ø (mm)	L2 (mm)	L1 (mm)	Código	Ø (mm)	L2 (mm)	L1 (mm)
40275	1,00	12	34	40300	3,10	36	65	40325	5,20	52	86	40350	7,25	69	109
40276	1,10	14	36	40301	3,20	36	65	40326	5,25	52	86	40351	7,30	69	109
40277	1,20	16	38	40302	3,25	36	65	40327	5,30	52	86	40352	7,40	69	109
40278	1,25	16	38	40303	3,30	36	65	40328	5,40	57	93	40353	7,50	69	109
40279	1,30	16	38	40304	3,40	39	70	40329	5,50	57	93	40354	7,60	75	117
40280	1,40	18	40	40305	3,50	39	70	40330	5,60	57	93	40355	7,70	75	117
40281	1,50	18	40	40306	3,60	39	70	40331	5,70	57	93	40356	7,75	75	117
40282	1,60	20	43	40307	3,70	39	70	40332	5,75	57	93	40357	7,80	75	117
40283	1,70	20	43	40308	3,75	39	70	40333	5,80	57	93	40358	7,90	75	117
40284	1,75	22	46	40309	3,80	43	75	40334	5,90	57	93	40359	8,00	75	117
40285	1,80	22	46	40310	3,90	43	75	40335	6,00	57	93	40360	8,10	75	117
40286	1,90	22	46	40311	4,00	43	75	40336	6,10	63	101	40361	8,20	75	117
40287	2,00	24	49	40312	4,10	43	75	40337	6,20	63	101	40362	8,25	75	117
40288	2,10	24	49	40313	4,20	43	75	40338	6,25	63	101	40363	8,30	75	117
40289	2,20	27	53	40314	4,25	43	75	40339	6,30	63	101	40364	8,40	75	117
40290	2,25	27	53	40315	4,30	47	80	40340	6,40	63	101	40365	8,50	75	117
40291	2,30	27	53	40316	4,40	47	80	40341	6,50	63	101	40366	8,60	81	125
40292	2,40	30	57	40317	4,50	47	80	40342	6,60	63	101	40367	8,70	81	125
40293	2,50	30	57	40318	4,60	47	80	40343	6,70	63	101	40368	8,75	81	125
40294	2,60	30	57	40319	4,70	47	80	40344	6,75	69	109	40369	8,80	81	125
40295	2,70	33	61	40320	4,75	47	80	40345	6,80	69	109	40370	8,90	81	125
40296	2,75	33	61	40321	4,80	52	86	40346	6,90	69	109	40371	9,00	81	125
40297	2,80	33	61	40322	4,90	52	86	40347	7,00	69	109	40372	9,10	81	125
40298	2,90	33	61	40323	5,00	52	86	40348	7,10	69	109	40373	9,20	81	125
40299	3,00	33	61	40324	5,10	52	86	40349	7,20	69	109	40374	9,25	81	125

### TW204

**Norma:** DIN 340  
**Material:** HSS  
**Ponta:** 118°  
**Acabamento:** Brilhante



Código	Ø (pol)	Ø (mm)	L2 (mm)	L1 (mm)	Código	Ø (pol)	Ø (mm)	L2 (mm)	L1 (mm)	Código	Ø (pol)	Ø (mm)	L2 (mm)	L1 (mm)	Código	Ø (pol)	Ø (mm)	L2 (mm)	L1 (mm)
41056		1,00	33	56	41064		1,75	53	80	41073		2,30	59	90	41081		2,80	66	100
41057		1,10	37	60	41065		1,80	53	80	41222	3/32"	2,38	62	95	41082		2,85	66	100
41219	3/64"	1,19	41	65	41066		1,90	53	80	41074		2,40	62	95	41083		2,90	66	100
41058		1,20	41	65	41221	5/64"	1,98	56	85	41075		2,50	62	95	41084		3,00	66	100
41059		1,30	41	65	41067		2,00	56	85	41076		2,55	62	95	41085		3,10	69	106
41060		1,40	45	70	41068		2,05	56	85	41077		2,60	62	95	41224	1/8"	3,18	69	106
41061		1,50	45	70	41069		2,10	56	85	41078		2,65	62	95	41086		3,20	69	106
41220	1/16"	1,59	50	76	41070		2,15	59	90	41079		2,70	66	100	41087		3,25	69	106
41062		1,60	50	76	41071		2,20	59	90	41080		2,75	66	100	41088		3,30	69	106
41063		1,70	50	76	41072		2,25	59	90	41223	7/64"	2,78	66	100	41089		3,40	73	112

**TW204** - continuação

Código	Ø (pol)	Ø (mm)	L2 (mm)	L1 (mm)
41090		3,50	73	112
41225	9/64"	3,57	73	112
41091		3,60	73	112
41092		3,70	73	112
41093		3,75	73	112
41094		3,80	78	119
41095		3,90	78	119
41226	5/32"	3,97	78	119
41096		4,00	78	119
41097		4,10	78	119
41098		4,20	78	119
41099		4,25	78	119
41100		4,30	82	126
41227	11/64"	4,37	82	126
41101		4,40	82	126
41102		4,50	82	126
41103		4,60	82	126
41104		4,70	82	126
41105		4,75	82	126
41228	3/16"	4,76	87	132
41106		4,80	87	132
41107		4,90	87	132
41108		5,00	87	132
41109		5,10	87	132
41229	13/64"	5,16	87	132
41110		5,20	87	132
41111		5,25	87	132
41112		5,30	87	132
41113		5,40	91	139
41114		5,50	91	139
41230	7/32"	5,56	91	139
41115		5,60	91	139
41116		5,70	91	139
41117		5,75	91	139
41118		5,80	91	139
41119		5,90	91	139
41231	15/64"	5,95	91	139
41120		6,00	91	139
41121		6,10	97	148

Código	Ø (pol)	Ø (mm)	L2 (mm)	L1 (mm)
41122		6,20	97	148
41123		6,25	97	148
41124		6,30	97	148
41232	1/4"	6,35	97	148
41125		6,40	97	148
41126		6,50	97	148
41127		6,60	97	148
41128		6,70	97	148
41233	17/64"	6,75	102	156
41129		6,75	102	156
41130		6,80	102	156
41131		6,90	102	156
41132		7,00	102	156
41133		7,10	102	156
41234	9/32"	7,14	102	156
41134		7,20	102	156
41135		7,25	102	156
41136		7,30	102	156
41137		7,40	102	156
41138		7,50	102	156
41139		7,60	109	165
41140		7,70	109	165
41141		7,75	109	165
41142		7,80	109	165
41143		7,90	109	165
41235	5/16"	7,94	109	165
41144		8,00	109	165
41145		8,10	109	165
41146		8,20	109	165
41147		8,25	109	165
41148		8,30	109	165
41149		8,40	109	165
41150		8,50	109	165
41151		8,60	115	175
41152		8,70	115	175
41236	11/32"	8,73	115	175
41153		8,75	115	175
41154		8,80	115	175
41155		8,90	115	175

Código	Ø (pol)	Ø (mm)	L2 (mm)	L1 (mm)
41156		9,00	115	175
41157		9,10	115	175
41158		9,20	115	175
41159		9,25	115	175
41160		9,30	115	175
41161		9,50	115	175
41237	3/8"	9,53	121	184
41162		9,60	121	184
41163		9,70	121	184
41164		9,75	121	184
41165		9,80	121	184
41166		9,90	121	184
41167		10,00	121	184
41168		10,10	121	184
41169		10,20	121	184
41170		10,25	121	184
41171		10,30	121	184
41238	13/32"	10,32	121	184
41172		10,40	121	184
41173		10,50	121	184
41174		10,60	121	184
41175		10,70	128	195
41176		10,75	128	195
41177		10,80	128	195
41178		11,00	128	195
41179		11,10	128	195
41239	7/16"	11,11	128	195
41180		11,20	128	195
41181		11,25	128	195
41182		11,30	128	195
41183		11,40	128	195
41184		11,50	128	195
41185		11,60	128	195
41186		11,70	128	195
41187		11,75	128	195
41188		11,80	128	195
41189		11,90	134	205
41240	15/32"	11,91	134	205
41190		12,00	134	205

Código	Ø (pol)	Ø (mm)	L2 (mm)	L1 (mm)
41191		12,25	134	205
41241	31/64"	12,30	134	205
41192		12,50	134	205
41242	1/2"	12,70	134	205
41193		12,75	134	205
41194		13,00	134	205
41195		13,25	140	214
41243	17/32"	13,49	140	214
41196		13,50	140	214
41197		14,00	140	214
41198		14,25	144	220
41244	9/16"	14,29	144	220
41199		14,50	144	220
41200		14,75	144	220
41201		15,00	144	220
41245	19/32"	15,08	149	227
41202		15,25	149	227
41203		15,50	149	227
41204		15,75	149	227
41246	5/8"	15,88	149	227
41205		16,00	149	227
41206		16,50	154	235
41207		17,00	154	235
41247	11/16"	17,46	158	241
41208		17,50	158	241
41209		18,00	158	241
41210		18,50	162	247
41211		19,00	162	247
41248	3/4"	19,05	166	254
41212		19,50	166	254
41213		20,00	166	254
41214		21,00	171	261
41215		22,00	176	268
41249	7/8"	22,23	177	268
41216		23,00	180	275
41250	15/16"	23,81	185	282
41217		24,00	185	282
41218		25,00	185	282
41251	1"	25,40	191	290

**FURAÇÕES PROFUNDAS**  
Até 6xØ com Brocas Standard

**Recomendações:**





Velocidade de corte (V<sub>c</sub>) e avanço por volta (A<sub>v</sub>) devem ser reduzidos em função do aumento da profundidade do furo:



























































































Profundidade do Furo	Redução V <sub>c</sub>	Redução A <sub>v</sub>
3xØ	10%	10%
4xØ	20%	10%
5xØ	30%	20%
6xØ	35 - 40%	20%

Classes de Materiais					A <sub>v</sub> - Avanço por Volta (mm)									Profundidade do Furo			
Tipo	Característica	Exemplos Classes / Normas (SAE - AISI)	Condição	Dureza	Velocidade de Corte (m/min)	1,59 mm 1/16"	3,17 mm 1/8"	6,35 mm 1/4"	9,52 mm 3/8"	12,70 mm 1/2"	15,87 mm 5/8"	19,05 mm 3/4"	25,40 mm 1"	Até 4xø	5 a 8xø	acima 8xø	
<b>AÇOS</b>																	
Usinagem Fácil Ressulfurado	Baixo Carbono	1110 - 1116 - 1119 - 1215	Sem Têmpera / Revenido	100 a 200 HB	21 - 40	0,025	0,075	0,130	0,215	0,300	0,375	0,450	0,550	●	●	○	
	Médio carbono	1132 - 1140 - 1151		175 a 225 HB	18 - 24	0,025	0,075	0,130	0,215	0,300	0,375	0,450	0,550	●	●	○	
Usinagem Fácil Chumbalois	Forjado Baixo Carbono	10L18 - 12L13 - 12L15	Sem Têmpera / Revenido	100 a 250 HB	18 - 43	0,025	0,075	0,130	0,215	0,300	0,375	0,450	0,550	●	●	○	
	Forjado Médio Carbono	10L45 - 10L50		Qualquer	125 a 225 HB	20 - 30	0,025	0,075	0,130	0,215	0,300	0,375	0,450	0,550	●	●	○
				Temperado e Revenido	325 a 425 HB	15 - 18	0,015	0,050	0,075	0,113	0,150	0,170	0,190	0,240	●	●	○
Aço Carbono	Forjado Baixo Carbono	1005 ao 1025	Qualquer	85 a 275 HB	20 - 29	0,025	0,075	0,130	0,180	0,230	0,265	0,300	0,360	●	●	○	
	Forjado Médio Carbono	1030 ao 1050	Sem Têmpera / Revenido	125 a 225 HB	17 - 26	0,025	0,075	0,130	0,180	0,230	0,265	0,300	0,400	●	●	○	
			Temperado e Revenido	225 a 425 HB	11 - 18	0,015	0,050	0,075	0,128	0,180	0,205	0,230	0,280	●	●	○	
Chapas	Estrutural, naval, aeronáutica, laminada	HY80 - HY100 MIL-S-12560/16216	Recozido	200 a 250 HB	11 - 13	0,020	0,050	0,075	0,113	0,150	0,175	0,200	0,250	●	○	○	
			Temperado e Revenido	250 HB a 45 HRc	8 - 11	0,020	0,050	0,075	0,103	0,130	0,165	0,200	0,250	○	○	○	
Estrutural	Aço ao Carbono de alta resistência	30 - 42 - 50 - 65 - 70 100 - 185 - 210	Qualquer	100 a 150 HB	15 - 18	0,025	0,075	0,150	0,200	0,250	0,290	0,330	0,400	●	●	○	
			Temperado e Revenido	150 HB a 50 HRc	5 - 15	0,010	0,025	0,050	0,063	0,075	0,089	0,102	0,102	○	○	○	
Aço Ligado para Beneficiamento	Baixo Carbono	4012 - 4320 - 4620 - 4720 5015 - 8620 - 94B17 (similares)	Laminado a Quente														
			Trefilado a Frio	125 a 275 HB	18 - 23	0,025	0,075	0,150	0,200	0,250	0,290	0,330	0,400	●	●	○	
			Recozido	225 a 275 HB	15 - 18	0,025	0,075	0,102	0,141	0,180	0,215	0,250	0,300	●	●	○	
			Temperado e Revenido	275 a 425 HB	9 - 15	0,010	0,050	0,075	0,103	0,130	0,165	0,200	0,230	●	●	○	
	Médio Carbono	1330 - 4027 - 4130 - 4140 4150 - 4340 - 4427 - 50B40 5060 - 5130 - 5135 - 5140 5160 - 8625 - 8630 - 8640 86B45 - 94B30 - 9260 (similares)	Laminado a Quente														
			Trefilado a Frio	125 a 225 HB	19 - 21	0,025	0,075	0,150	0,200	0,250	0,305	0,360	0,400	●	●	○	
			Recozido	225 a 275 HB	16 - 18	0,015	0,050	0,090	0,115	0,140	0,170	0,200	0,230	●	●	○	
			Temperado e Revenido	275 HB a 52 HRc	3 - 15	0,015	0,025	0,025	0,025	0,025	0,038	0,050	0,075	○	○	○	
	Alto Carbono	50100 - 51100 52100 - M50 (similares)	Laminado a Quente														
			Trefilado a Frio	175 a 225 HB	16 - 17	0,025	0,075	0,150	0,215	0,280	0,320	0,360	0,400	●	●	○	
			Recozido	225 a 275 HB	14 - 15	0,025	0,075	0,102	0,141	0,180	0,215	0,250	0,300	●	●	○	
			Temperado e Revenido	275 HB a 52 HRc	3 - 11	0,010	0,025	0,050	0,063	0,075	0,075	0,075	0,102	○	○	○	
Alta Resistência	Alta Resistência Mecânica	300M - 4330V - 4340 4340Si - 98BV40 - D6ac HP9-4-25 HP9-4-45	Recozido	225 a 300 HB	14 - 16	0,025	0,075	0,102	0,141	0,180	0,215	0,250	0,300	●	●	○	
			Normalizado	300 a 400 HB	9 - 11	0,012	0,050	0,102	0,126	0,150	0,180	0,210	0,250	●	●	○	
			Temperado e Revenido	43 a 52 HRc	3 - 6	0,010	0,025	0,050	0,063	0,075	0,075	0,075	0,102	○	○	○	
Aço Ferramenta	Aços Rápidos	M1 - M2 - M35 - T15 - M42	Recozido	200 a 275 HB	8 - 14	0,025	0,050	0,075	0,103	0,130	0,155	0,180	0,200	●	●	○	
				150 a 200 HB	17 - 19	0,025	0,050	0,075	0,113	0,150	0,190	0,230	0,280	●	●	○	
	Trabalho a Quente	H10 - H11 - H12 H13 - H19 - H22 H25 - H42	Temperado e Revenido	200 a 250 HB	14 - 16	0,025	0,050	0,075	0,113	0,150	0,175	0,200	0,250	●	●	○	
				325 a 375 HB	11 - 13	0,012	0,050	0,075	0,103	0,130	0,155	0,180	0,200	●	●	○	
	Trabalho a Frio	A2 - A4 - A7 - A10 - D2 - D3 D7 - O1 - O6 (similares)	Recozido	200 a 250 HB	9 - 14	0,025	0,025	0,075	0,103	0,130	0,155	0,180	0,200	●	○	○	
				175 a 225 HB	16 - 18	0,025	0,050	0,075	0,128	0,180	0,205	0,230	0,280	●	●	○	
Aço para Moldes		P2 - P4 - P5 - P20 - P21		100 a 200 HB	18 - 23	0,025	0,050	0,075	0,128	0,180	0,205	0,230	0,280	●	●	○	
<b>NIQUEL</b>																	
Não Ligado	Puro		Recozido	80 a 170 HB	19 - 22	0,010	0,075	0,150	0,200	0,250	0,305	0,360	0,450	○	○	○	
Ligas de Média a Alta Resistência	Monel		Qualquer	115 a 240 HB	16 - 18	0,010	0,075	0,130	0,180	0,230	0,265	0,300	0,360	○	○	○	
	Inconel		Solubilizado e Envelhecido	200 a 400 HB	5 - 6	0,010	0,050	0,075	0,075	0,075	0,089	0,102	0,200	○	○	○	
	Hastelloy			140 a 375 HB	2 - 6	0,010	0,050	0,075	0,075	0,075	0,089	0,102	0,180	○	○	○	







## LEGENDA





























































































-  EXCELENTE PARA APLICAÇÃO
-  BOM PARA APLICAÇÃO
-  NÃO RECOMENDADO
-  NÃO SE APLICA

Classes de Materiais						A <sub>v</sub> - Avanço por Volta (mm)									Profundidade do Furo	
Tipo	Característica	Exemplos Classes / Normas (SAE - AISI)	Condição	Dureza	Velocidade de Corte (m/min)	1,59 mm 1/16"	3,17 mm 1/8"	6,35 mm 1/4"	9,52 mm 3/8"	12,70 mm 1/2"	15,87 mm 5/8"	19,05 mm 3/4"	25,40 mm 1"	Até 4xø	5 a 8xø acima 8xø	
<b>AÇO INOX</b>																
<b>Usinagem Fácil</b>	Ferrítico e Austenítico	430F - 303P6 303MA - 303SE	Recozido	135 a 185 HB	30 - 50	0,025	0,075	0,150	0,200	0,250	0,305	0,360	0,450			
	Martensítico	416 - 416SE - 420F Se 440F (similares)		Temperado e Revenido	135 a 240 HB	38 - 44	0,025	0,075	0,150	0,200	0,250	0,305	0,360	0,450		
<b>Série 400</b>	Ferrítico	405 - 409 - 429 - 430 436 - 446 (similares)	Recozido	135 a 185 HB	19 - 21	0,025	0,050	0,102	0,141	0,180	0,215	0,250	0,300			
<b>Série 300</b>	Austenítico	301 - 304 - 304L - 308 - 321 347 - 348 - 385 - 302B 310 - 316 (similares)	Qualquer	135 a 275 HB	15 - 18	0,025	0,050	0,102	0,141	0,180	0,215	0,250	0,300			
<b>Endurecível</b>	Martensítico	403 - 410 - 420 - 422 501 - 502 (similares)	Recozido	135 a 225 HB	17 - 20	0,025	0,075	0,150	0,200	0,250	0,290	0,330	0,400			
			Temperado e Revenido	275 a 425 HB	13 - 17	0,012	0,025	0,050	0,076	0,102	0,102	0,102	0,102	0,102		
<b>FERRO FUNDIDO</b>																
<b>Cinzento</b>	Ferrítico	ASTM A48: Classes 20 - 25	Recozido	120 a 150 HB	27 - 49	0,025	0,075	0,150	0,225	0,300	0,375	0,450	0,550			
	Perlítico	ASTM A48: Classes 30 - 35 40 - 45 - 50	Fundido	160 a 260 HB	17 - 32	0,025	0,060	0,110	0,180	0,250	0,300	0,350	0,450			
	Perlítico Endurecido	ASTM A48: Classes 55 - 60	Qualquer	250 a 320 HB	14 - 16	0,025	0,050	0,102	0,141	0,180	0,215	0,250	0,300			
<b>Nodular / Dúctil</b>	Ferrítico	ASTM A395	Fundido	185 a 255 HB	17 - 29	0,025	0,060	0,110	0,155	0,200	0,300	0,400	0,400			
	Ferrítico / Perlítico / Martensítico	ASTM A536	Recozido	140 a 190 HB	26 - 35	0,025	0,075	0,150	0,200	0,250	0,290	0,330	0,400			
			Fundido	190 a 260 HB	15 - 21	0,025	0,050	0,102	0,141	0,180	0,215	0,250	0,300			
			Temperado e Revenido	270 a 400 HB	6 - 14	0,012	0,025	0,050	0,076	0,102	0,116	0,130	0,150			
<b>Maleável</b>	Ferrítico	ASTM A47 - A602	Maleabilizado	110 a 160 HB	39 - 41	0,025	0,075	0,150	0,200	0,250	0,290	0,330	0,400			
	Perlítico	ASTM A47 - A220 / A602	Maleabilizado e Tratado	160 a 240 HB	26 - 30	0,025	0,060	0,130	0,170	0,210	0,245	0,280	0,350			
	Martensítico	ASTM A47 - A220 / A602		200 a 320 HB	18 - 27	0,012	0,050	0,102	0,116	0,130	0,140	0,150	0,150			
<b>Branco</b>	Resistente Abrasão	ASTM A532	Recozido	400 HB	4 - 6	0,008	0,050	0,075	0,089	0,102	0,116	0,130	0,130			
<b>ALUMÍNIO</b>																
<b>Ligado</b>	Ligas ao Magnésio / Mg-Si (forjadas)	5050 - 5456 - 6061 6262 - 7050 (similares)	Trefilado a Frio	30 a 80 HB	43 - 105	0,025	0,075	0,180	0,240	0,300	0,350	0,400	0,500			
			Solubilizado e Envelhecido	75 a 125 HB	43 - 84	0,025	0,075	0,180	0,240	0,300	0,350	0,400	0,500			
	Ligas ao Silício / Al-Si (fundidas)	308.0 - A332.0 355.0 - C443.0 (similares)	Fundido	40 a 100 HB	27 - 90	0,025	0,075	0,180	0,240	0,300	0,350	0,400	0,500			
				40 a 100 HB	8 - 15	0,025	0,075	0,180	0,240	0,300	0,350	0,400	0,500			
	Ligas de Alta Resistência	390.0 - 392.0 (similares)	Solubilizado e Envelhecido	70 a 125 HB	8 - 14	0,025	0,075	0,180	0,240	0,300	0,350	0,400	0,500			
<b>COBRE</b>																
<b>Cobre Ligado</b>	Baixa Liga/Cavaco extra-longo		Fundido	40 a 150 HB	43 - 60	0,025	0,075	0,150	0,200	0,250	0,290	0,330	0,400			
<b>Latões e Bronzes</b>	Cavaco médio		Forjado	60 a 100 Rb	15 - 45	0,025	0,075	0,150	0,200	0,250	0,290	0,330	0,400			
<b>Latões</b>	Cavaco médio/curto			60 a 100 Rb	15 - 45	0,025	0,075	0,150	0,200	0,250	0,290	0,330	0,400			
<b>Bronze</b>	Cavaco curto			60 a 100 Rb	15 - 45	0,025	0,075	0,150	0,200	0,250	0,290	0,330	0,400			
<b>TITÂNIO</b>																
<b>Não Ligado</b>	Puro		Fundido	110 a 170 HB	24 - 34	0,013	0,050	0,130	0,165	0,200	0,225	0,250	0,300			
<b>Ligado</b>	Alfa Ligas / Beta Ligas		Recozido	150 a 200 HB	18 - 34	0,013	0,050	0,130	0,165	0,200	0,225	0,250	0,300			
				200 a 350 HB	8 - 18	0,010	0,025	0,050	0,063	0,075	0,089	0,102	0,102			
<b>PLÁSTICOS</b>																
<b>Termo-Fibrosos</b>	Polietileno, Acrílicos			60 R <sub>M</sub> a 120 R <sub>R</sub>	20 - 60	0,025	0,050	0,102	0,116	0,130	0,140	0,150	0,200			
<b>Termo-Ajustáveis</b>	Resinosos, Nylon															

Classes de Materiais					A <sub>v</sub> - Avanço por Volta (mm)						Profundidade do Furo			
Tipo	Característica	Exemplos Classes / Normas (SAE - AISI)	Condição	Dureza	Velocidade de Corte (m/min)	1,59 mm / 1/16"	3,17 mm / 1/8"	6,35 mm / 1/4"	9,52 mm / 3/8"	12,70 mm / 1/2"	Até 4x0	5 a 8x0	acima 8x0	
<b>AÇOS</b>														
<b>Usinagem Fácil</b>	Baixo Carbono	1110 - 1116 - 1119 - 1215	Sem Têmpera / Revenido	100 a 200 HB	21 - 40	0,025	0,075	0,130	0,215	0,300	●	●	●	
	Médio Carbono	1132 - 1140 - 1151		175 a 225 HB	18 - 24	0,025	0,075	0,130	0,215	0,300	●	●	●	
<b>Ressulfurado</b>			Temperado e Revenido	275 a 375 HB	11 - 21	0,015	0,075	0,130	0,205	0,280	●	●	●	
	<b>Usinagem Fácil Chumbalois</b>	Forjado Baixo Carbono	10L18 - 12L13 - 12L15	Sem Têmpera / Revenido	100 a 250 HB	18 - 43	0,025	0,075	0,130	0,215	0,300	●	●	●
Forjado Médio Carbono		10L45 - 10L50	Qualquer	125 a 225 HB	20 - 30	0,025	0,075	0,130	0,215	0,300	●	●	●	
			Temperado e Revenido	325 a 425 HB	15 - 18	0,015	0,050	0,075	0,113	0,150	●	●	●	
<b>Aço Carbono</b>	Forjado Baixo Carbono	1005 ao 1025	Qualquer	85 a 275 HB	20 - 29	0,025	0,075	0,130	0,180	0,230	●	●	●	
	Forjado Médio Carbono	1030 ao 1050	Sem Têmpera / Revenido	125 a 225 HB	17 - 26	0,025	0,075	0,130	0,180	0,230	●	●	●	
			Temperado e Revenido	225 a 425 HB	11 - 18	0,015	0,050	0,075	0,128	0,180	●	●	●	
	Forjado Alto Carbono	1060 ao 1572	Sem Têmpera / Revenido	175 a 225 HB	14 - 20	0,025	0,075	0,130	0,180	0,230	●	●	●	
Temperado e Revenido			225 a 425 HB	9 - 17	0,015	0,050	0,075	0,113	0,150	●	●	●		
<b>Chapas</b>	Estrutural, naval, aeronáutica, laminada	HY80 - HY100 MIL-S-12560/16216	Recozido	200 a 250 HB	11 - 13	0,020	0,050	0,075	0,113	0,150	●	●	●	
			Temperado e Revenido	250 HB a 45 HRc	8 - 11	0,020	0,050	0,075	0,103	0,130	●	●	●	
<b>Estrutural</b>	Aço ao Carbono de alta resistência	30 - 42 - 50 - 65 - 70 100 - 185 - 210	Qualquer	100 a 150 HB	15 - 18	0,025	0,075	0,150	0,200	0,250	●	●	●	
			Temperado e Revenido	150 HB a 50 HRc	5 - 15	0,010	0,025	0,050	0,063	0,075	●	●	●	
<b>Aço Ligado para Beneficiamento</b>	Baixo Carbono	4012 - 4320 - 4620 - 4720 5015 - 8620 - 94B17 (similares)	Laminado a Quente	125 a 275 HB	18 - 23	0,025	0,075	0,150	0,200	0,250	●	●	●	
			Trefilado a Frio											
			Recozido											
			Normalizado								225 a 275 HB	15 - 18	0,025	0,075
		Médio Carbono	1330 - 4027 - 4130 - 4140 4150 - 4340 - 4427 - 50B40 5060 - 5130 - 5135 - 5140 5160 - 8625 - 8630 - 8640 86B45 - 94B30 - 9260 (similares)	Laminado a Quente	125 a 225 HB	19 - 21	0,025	0,075	0,150	0,200	0,250	●	●	●
				Trefilado a Frio										
				Recozido										
				Normalizado								225 a 275 HB	16 - 18	0,015
		Alto Carbono	50100 - 51100 52100 - M50 (similares)	Laminado a Quente	175 a 225 HB	16 - 17	0,025	0,075	0,150	0,215	0,280	●	●	●
				Trefilado a Frio										
				Recozido										
				Normalizado								225 a 275 HB	14 - 15	0,025
	Alta Resistência Mecânica	300M - 4330V - 4340 4340Si - 98BV40 - D6ac HP9-4-25 - HP9-4-45	Recozido	225 a 300 HB	14 - 16	0,025	0,075	0,102	0,141	0,180	●	●	●	
			Normalizado	300 a 400 HB	9 - 11	0,012	0,050	0,102	0,126	0,150	●	●	●	
			Temperado e Revenido	43 a 52 HRc	3 - 6	0,010	0,025	0,050	0,063	0,075	●	●	●	
						200 a 275 HB	8 - 14	0,025	0,050	0,075	0,103	0,130	●	●
<b>Aço Ferramenta</b>	Aços Rápidos	M1 - M2 - M35 - T15 - M42	Recozido	150 a 200 HB	17 - 19	0,025	0,050	0,075	0,113	0,150	●	●	●	
				200 a 250 HB	14 - 16	0,025	0,050	0,075	0,113	0,150	●	●	●	
	Trabalho a Quente	H10 - H11 - H12 H13 - H19 - H22 H25 - H42	Temperado e Revenido	325 a 375 HB	11 - 13	0,012	0,050	0,075	0,103	0,130	●	●	●	
				48 a 52 HRc	5 - 7	0,012	0,025	0,050	0,063	0,075	●	●	●	
	Trabalho a Frio	A2 - A4 - A7 - A10 - D2 - D3 D7 - O1 - O6 (similares)	Recozido	200 a 250 HB	9 - 14	0,025	0,025	0,075	0,103	0,130	●	●	●	
	Resistente ao Choque	S1 - S2 - S5 - S6 - S7		175 a 225 HB	16 - 18	0,025	0,050	0,075	0,128	0,180	●	●	●	
Aço para Moldes	P2 - P4 - P5 - P20 - P21		100 a 200 HB	18 - 23	0,025	0,050	0,075	0,128	0,180	●	●	●		
<b>NÍQUEL</b>														
<b>Não Ligado</b>	Puro		Recozido	80 a 170 HB	19 - 22	0,010	0,075	0,150	0,200	0,250	●	●	●	
<b>Ligas de Média a Alta Resistência</b>	Monel		Qualquer	115 a 240 HB	16 - 18	0,010	0,075	0,130	0,180	0,230	●	●	●	
	Inconel		Solubilizado e Envelhecido	200 a 400 HB	5 - 6	0,010	0,050	0,075	0,075	0,075	●	●	●	
	Hastelloy			140 a 375 HB	2 - 6	0,010	0,050	0,075	0,075	0,075	●	●	●	

## LEGENDA

-  EXCELENTE PARA APLICAÇÃO
-  BOM PARA APLICAÇÃO
-  NÃO RECOMENDADO
-  NÃO SE APLICA

Classes de Materiais						A <sub>v</sub> - Avanço por Volta (mm)					Profundidade do Furo		
Tipo	Característica	Exemplos Classes / Normas (SAE - AISI)	Condição	Dureza	Velocidade de Corte (m/min)	1,59 mm 1/16"	3,17 mm 1/8"	6,35 mm 1/4"	9,52 mm 3/8"	12,70 mm 1/2"	Até 4xφ	5 a 8xφ	acima 8xφ
<b>AÇO INOX</b>													
<b>Usinagem Fácil</b>	Ferrítico e Austenítico	430F - 303P6 303MA - 303SE	Recozido	135 a 185 HB	30 - 50	0,025	0,075	0,150	0,200	0,250			
	Martensítico	416 - 416SE - 420F Se 440F (similares)		Temperado e Revenido	135 a 240 HB	38 - 44	0,025	0,075	0,150	0,200	0,250		
<b>Série 400</b>	Ferrítico	405 - 409 - 429 - 430 436 - 446 (similares)	Recozido	135 a 185 HB	19 - 21	0,025	0,050	0,102	0,141	0,180			
<b>Série 300</b>	Austenítico	301 - 304 - 304L - 308 - 321 347 - 348 - 385 - 302B 310 - 316 (similares)	Qualquer	135 a 275 HB	15 - 18	0,025	0,050	0,102	0,141	0,180			
<b>Endurecível</b>	Martensítico	403 - 410 - 420 - 422 501 - 502 (similares)	Recozido	135 a 225 HB	17 - 20	0,025	0,075	0,150	0,200	0,250			
			Temperado e Revenido	275 a 425 HB	13 - 17	0,012	0,025	0,050	0,076	0,102			
<b>FERRO FUNDIDO</b>													
<b>Cinzeno</b>	Ferrítico	ASTM A48: Classes 20 - 25	Recozido	120 a 150 HB	27 - 49	0,025	0,075	0,150	0,225	0,300			
	Perlítico	ASTM A48: Classes 30 - 35 40 - 45 - 50	Fundido	160 a 260 HB	17 - 32	0,025	0,060	0,110	0,180	0,250			
	Perlítico Endurecido	ASTM A48: Classes 55 - 60	Qualquer	250 a 320 HB	14 - 16	0,025	0,050	0,102	0,141	0,180			
<b>Nodular / Dúctil</b>	Ferrítico	ASTM A395	Fundido	185 a 255 HB	17 - 29	0,025	0,060	0,110	0,155	0,200			
	Ferrítico / Perlítico / Martensítico	ASTM A536	Recozido	140 a 190 HB	26 - 35	0,025	0,075	0,150	0,200	0,250			
			Fundido	190 a 260 HB	15 - 21	0,025	0,050	0,102	0,141	0,180			
			Temperado e Revenido	270 a 400 HB	6 - 14	0,012	0,025	0,050	0,076	0,102			
<b>Maleável</b>	Ferrítico	ASTM A47 - A602	Maleabilizado	110 a 160 HB	39 - 41	0,025	0,075	0,150	0,200	0,250			
	Perlítico	ASTM A47 - A220 / A602	Maleabilizado e Tratado	160 a 240 HB	26 - 30	0,025	0,060	0,130	0,170	0,210			
	Martensítico	ASTM A47 - A220 / A602		200 a 320 HB	18 - 27	0,012	0,050	0,102	0,116	0,130			
<b>Branco</b>	Resistente Abrasão	ASTM A532	Recozido	400 HB	4 - 6	0,008	0,050	0,075	0,089	0,102			
<b>ALUMÍNIO</b>													
<b>Ligado</b>	Ligas ao Magnésio / Mg-Si (forjadas)	5050 - 5456 - 6061 6262 - 7050 (similares)	Trefilado a Frio	30 a 80 HB	43 - 105	0,025	0,075	0,180	0,240	0,300			
			Solubilizado e Envelhecido	75 a 125 HB	43 - 84	0,025	0,075	0,180	0,240	0,300			
	Ligas ao Silício / Al-Si (fundidas)	308.0 - A332.0 355.0 - C443.0 (similares)	Fundido	40 a 100 HB	43 - 105	0,025	0,075	0,180	0,240	0,300			
				40 a 100 HB	8 - 15	0,025	0,075	0,180	0,240	0,300			
	Ligas de Alta Resistência	390.0 - 392.0 (similares)	Solubilizado e Envelhecido	70 a 125 HB	8 - 14	0,025	0,075	0,180	0,240	0,300			
<b>COBRE</b>													
<b>Cobre Ligado</b>	Baixa Liga/Cavaco extra-longo		Fundido	40 a 150 HB	43 - 60	0,025	0,075	0,150	0,200	0,250			
<b>Latões e Bronzes</b>	Cavaco médio		Forjado	60 a 100 Rb	15 - 45	0,025	0,075	0,150	0,200	0,250			
<b>Latões</b>	Cavaco médio/curto			60 a 100 Rb	15 - 45	0,025	0,075	0,150	0,200	0,250			
<b>Bronze</b>	Cavaco curto			60 a 100 Rb	15 - 45	0,025	0,075	0,150	0,200	0,250			
<b>TITÂNIO</b>													
<b>Não Ligado</b>	Puro		Recozido	110 a 170 HB	24 - 34	0,013	0,050	0,130	0,165	0,200			
<b>Ligado</b>	Alfa Ligas / Beta Ligas		Fundido	150 a 200 HB	18 - 34	0,013	0,050	0,130	0,165	0,200			
			Recozido	200 a 350 HB	8 - 18	0,010	0,025	0,050	0,063	0,075			
<b>PLÁSTICOS</b>													
<b>Termo-Fibrosos</b>	Polietileno, Acrílicos			60 R <sub>M</sub> a 120 R <sub>R</sub>	20 - 60	0,025	0,050	0,102	0,116	0,130			
<b>Termo-Ajustáveis</b>	Resinosos, Nylon												

## CONJUNTO EM ESTOJO ABS ALTO IMPACTO

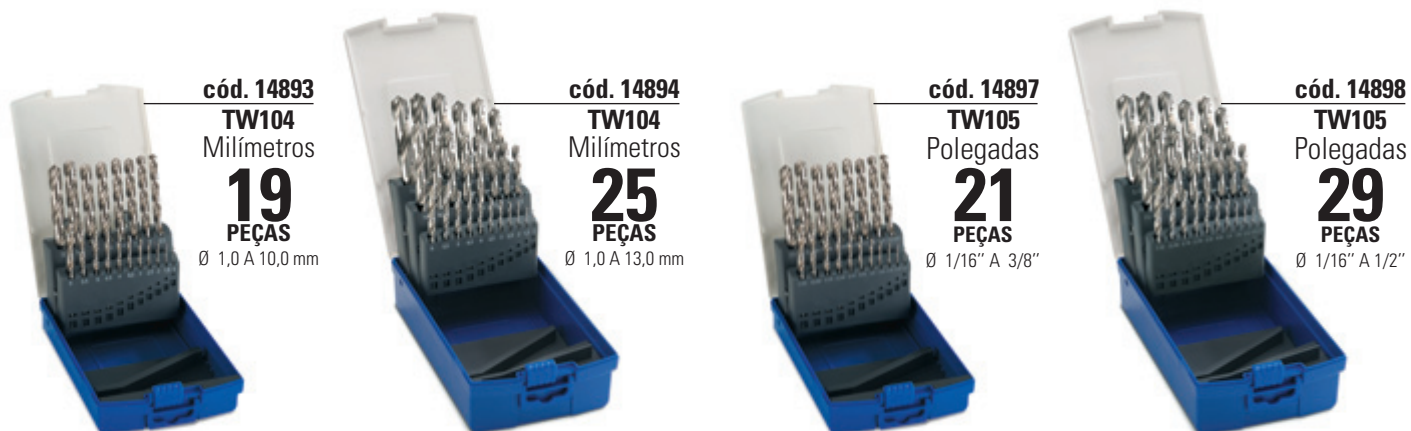

cód. 14893  
TW104  
Milímetros  
**19**  
PEÇAS  
Ø 1,0 A 10,0 mm

cód. 14894  
TW104  
Milímetros  
**25**  
PEÇAS  
Ø 1,0 A 13,0 mm

cód. 14897  
TW105  
Polegadas  
**21**  
PEÇAS  
Ø 1/16" A 3/8"

cód. 14898  
TW105  
Polegadas  
**29**  
PEÇAS  
Ø 1/16" A 1/2"

## INSTRUÇÕES PARA REAFIAÇÃO

Manter ângulo de ponta com  $118^\circ \pm 3^\circ$

Manter ângulo da aresta transversal com  $130^\circ \pm 5^\circ$

**A:** Ângulo de folga da afiação varia de  $7^\circ$  a  $20^\circ$  em função do Ø:

Ø 1,00 a Ø 2,40  $\Rightarrow 13^\circ$  a  $20^\circ$

Ø 2,50 a Ø 3,00  $\Rightarrow 11^\circ$  a  $16^\circ$

Ø 3,10 a Ø 6,30  $\Rightarrow 9^\circ$  a  $14^\circ$

Ø 6,40 a Ø 8,70  $\Rightarrow 8^\circ$  a  $13^\circ$

Ø 8,80 a Ø 13,00  $\Rightarrow 7^\circ$  a  $11^\circ$

## CUIDADOS AO FAZER REAFIAÇÕES DE PONTA E REDUÇÃO DE NÚCLEO:

- Usar sempre rebolo de granulação fina
- Retificar lentamente para evitar queimas superficiais e perda de propriedades e dureza

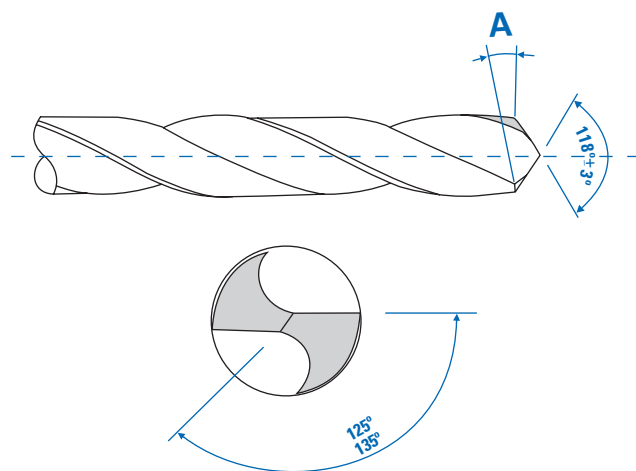

**LENOX**   
**Twill**

Av. Presidente Kennedy, 1049  
Carlos Barbosa/RS - CEP 95185-000  
Fone: +55 54 3461-1428  
Fax: +55 54 3461-1344  
www.lenox-twill.com

